

PERFORMANCE  
MADE  
SMARTER

# Product manual

## 9107

### *HART transparent driver*



Segurança  
INMETRO



ClassNK  
APPROVED



EAC

UK  
CA



TEMPERATURE | I.S. INTERFACES | COMMUNICATION INTERFACES | MULTIFUNCTIONAL | ISOLATION | DISPLAY

No. 9107V108-UK  
Product version: 9107-002

**PR**  
electronics

# 6 Product Pillars

## *to meet your every need*

### Individually outstanding, unrivalled in combination

With our innovative, patented technologies, we make signal conditioning smarter and simpler. Our portfolio is composed of six product areas, where we offer a wide range of analog and digital devices covering over a thousand applications in industrial and factory automation. All our products comply with or surpass the highest industry standards, ensuring reliability in even the harshest of environments and have a 5-year warranty for greater peace of mind.

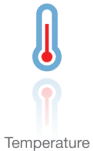

Temperature

Our range of temperature transmitters and sensors provides the highest level of signal integrity from the measurement point to your control system. You can convert industrial process temperature signals to analog, bus or digital communications using a highly reliable point-to-point solution with a fast response time, automatic self-calibration, sensor error detection, low drift, and top EMC performance in any environment.



I.S. Interface

We deliver the safest signals by validating our products against the toughest safety standards. Through our commitment to innovation, we have made pioneering achievements in developing I.S. interfaces with SIL 2 Full Assessment that are both efficient and cost-effective. Our comprehensive range of analog and digital intrinsically safe isolation barriers offers multifunctional inputs and outputs, making PR an easy-to-implement site standard. Our backplanes further simplify large installations and provide seamless integration to standard DCS systems.



Communication

We provide inexpensive, easy-to-use, future-ready communication interfaces that can access your PR installed base of products. All the interfaces are detachable, have a built-in display for readout of process values and diagnostics, and can be configured via push-buttons. Product specific functionality includes communication via Modbus and Bluetooth and remote access using our PR Process Supervisor (PPS) application, available for iOS and Android.



Multifunction

Our unique range of single devices covering multiple applications is easily deployable as your site standard. Having one variant that applies to a broad range of applications can reduce your installation time and training, and greatly simplify spare parts management at your facilities. Our devices are designed for long-term signal accuracy, low power consumption, immunity to electrical noise and simple programming.



Isolation

Our compact, fast, high-quality 6 mm isolators are based on microprocessor technology to provide exceptional performance and EMC-immunity for dedicated applications at a very low total cost of ownership. They can be stacked both vertically and horizontally with no air gap separation between units required.



Display

Our display range is characterized by its flexibility and stability. The devices meet nearly every demand for display readout of process signals and have universal input and power supply capabilities. They provide a real-time measurement of your process value no matter the industry and are engineered to provide a user-friendly and reliable relay of information, even in demanding environments.

# HART transparent driver

## 9107

### Table of contents

Warning .....	4
Symbol identification .....	4
Safety instructions .....	4
Marking .....	5
How to demount system 9000 .....	6
Mounting the PR 4500 communication interfaces .....	6
Application .....	7
Advanced features .....	7
Technical characteristics .....	7
Applications - 9107Axx .....	8
Applications - 9107Bxx .....	9
Order .....	10
Accessories .....	10
Technical data .....	10
Visualisation in the PR 4500 of hardware / software error .....	13
Connections .....	14
Block diagram .....	15
Signal error indications without display front .....	16
Configuration / operating the function keys .....	17
Routing diagram .....	18
Routing diagram, advanced settings (ADV.SET) .....	19
Help text overview .....	20
IECEX Installation Drawing .....	21
ATEX / UKEX Installation Drawing .....	24
FM Installation Drawing .....	28
UL Installation Drawing .....	30
Desenho de instalação INMETRO .....	35
KCs IECEX Installation Drawing .....	37
Document history .....	40

## Warning



The following operations should only be carried out on a disconnected device and under ESD-safe conditions:

- General mounting, wire connection and disconnection.
- Troubleshooting the device.

**Repair of the device and replacement of circuit breakers must be done by PR electronics A/S only.**

## Warning



Do not open the front plate of the device as this will cause damage to the connector for the display / programming front PR 4500.

This device contains no DIP-switches or jumpers.

## Symbol identification



**Triangle with an exclamation mark:** Read the manual before installation and commissioning of the device in order to avoid incidents that could lead to personal injury or mechanical damage. Warning/demand. Potentially lethal situations.



**The CE mark** proves the compliance of the device with the essential requirements of the directives.



**The UKCA mark** proves the compliance of the device with the essential requirements of the UK regulations.



**The double insulation symbol** shows that the device is protected by double or reinforced insulation.



**Ex devices** have been approved acc. to the ATEX directive for use in connection with installations in explosive areas. See installation drawings in appendix.

## Safety instructions

### Definitions

**Hazardous voltages** have been defined as the ranges: 75 to 1500 Volt DC, and 50 to 1000 Volt AC.

**Technicians** are qualified persons educated or trained to mount, operate, and also trouble-shoot technically correct and in accordance with safety regulations.

**Operators**, being familiar with the contents of this manual, adjust and operate the knobs or potentiometers during normal operation.

### Receipt and unpacking

Unpack the device without damaging it and check whether the device type corresponds to the one ordered. The packing should always follow the device until this has been permanently mounted.

### Environment

Avoid direct sun light, dust, high temperatures, mechanical vibrations and shock, and rain and heavy moisture. If necessary, heating in excess of the stated limits for ambient temperatures should be avoided by way of ventilation.

The device must be installed in pollution degree 2 or better.

The device is designed to be safe at least under an altitude up to 2 000 m.

The device is designed for indoor use.

## Mounting

Only technicians, who are familiar with the technical terms, warnings, and instructions in the manual and who are able to follow these, should connect the device. Should there be any doubt as to the correct handling of the device, please contact your local distributor or, alternatively,

**PR electronics A/S**  
**www.prelectronics.com**

The use of stranded wires is not permitted for mains wiring except when wires are fitted with cable ends.

Stranded wire should be installed with an insulation stripping length of 5 mm or via a suitable insulated terminal such as a bootlace ferrule.

Descriptions of input / output and supply connections are shown in the block diagram and on the side label.

The device is provided with field wiring terminals and shall be supplied from a Power Supply having double / reinforced insulation. A power switch shall be easily accessible and close to the device. The power switch shall be marked as the disconnecting unit for the device.

For installation on Power Rail 9400 the power is supplied by Power Control Unit 9410.

Year of manufacture can be taken from the first two digits in the serial number.

## Calibration and adjustment

During calibration and adjustment, the measuring and connection of external voltages must be carried out according to the specifications of this manual. The technician must use tools and instruments that are safe to use.

## Normal operation

Operators are only allowed to adjust and operate devices that are safely fixed in panels, etc., thus avoiding the danger of personal injury and damage. This means there is no electrical shock hazard, and the device is easily accessible.

## Cleaning

When disconnected, the device may be cleaned with a cloth moistened with distilled water.

## Liability

To the extent the instructions in this manual are not strictly observed, the customer cannot advance a demand against PR electronics A/S that would otherwise exist according to the concluded sales agreement.

## Marking

When this product has been installed as Ex ia or / and ec, use a permanent marker in the appropriate box to indicate the type of installation on the label.

# How to demount system 9000

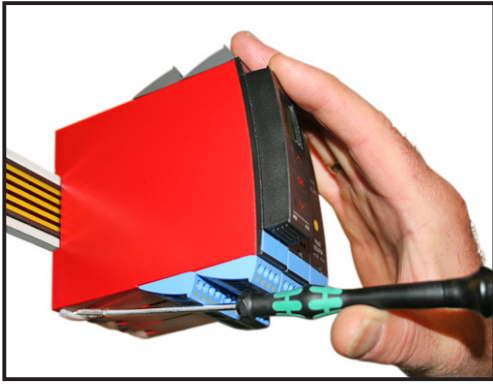

Picture 1:

By lifting the bottom lock, the device is detached from the DIN rail.

## Mounting the PR 4500 communication interfaces

- 1: Insert the tabs of the PR 4500 into the slots at the top of the device.
- 2: Hinge the PR 4500 down until it snaps into place.

## Demounting of the PR 4500 communication interfaces

- 3: Push the release button on the bottom of the PR 4500 and hinge the PR 4500 out and up.
- 4: With the PR 4500 hinged up, remove from the slots at the top of the device.

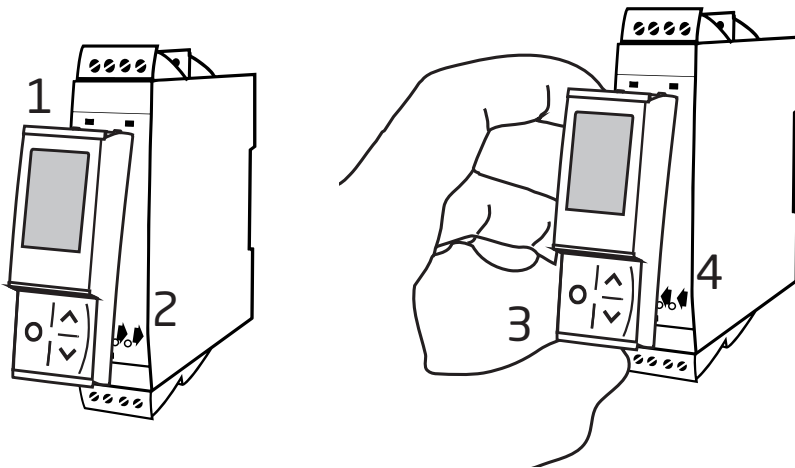

# HART transparent driver 9107

- 24 VDC supply via power rail or connectors
- Fast response time <5 ms
- High active output load 725 Ohm / 20 mA
- Output line fault detection via status relay
- SIL2 certified via Full Assessment according to IEC 61508

## Application

- 9107 is a 1- or 2-channel isolated 1:1 driver barrier for intrinsic safety applications.
- Operation and drive control of I/P converters, valves and indicators mounted in the hazardous area.
- Operation of HART devices is possible as the unit transmits HART communication signals bi-directionally.
- 9107Axx can be mounted in the safe area or in zone 2 / Class I, Division 2, Groups A, B, C, D.
- 9107Bxx can be mounted in the safe area or in zone 2 / Class 1, Division 2 and transmit signals to zone 0, 1, 2 and zone 20, 21, 22 including mining / Class I/II/III, Division 1, Gr. A-G.
- The PR 4500 displays the process value for each channel and can be used to define high and low limits for detection of loop current level. If these limits are exceeded, the status relay will activate.
- Dual channel versions can be used for signal splitter applications - 1 in and 2 out.

## Advanced features

- The PR 4500 detachable display and the green and red front LEDs indicate operation status for each channel.
- A tag number can be defined for each channel.
- Output line fault detection.
- In the 1-channel version the status relay can be used as a simple limit switch.
- Suitable for the use in systems up to Performance Level "d" according to ISO-13849.

## Technical characteristics

- High galvanic isolation of 2.6 kVAC.
- High accuracy better than 0.1%.
- Continuous check of vital stored data for safety reasons.

# Applications - 9107Axx

Output signals:

Input signals:

Analog, 4...20 mA

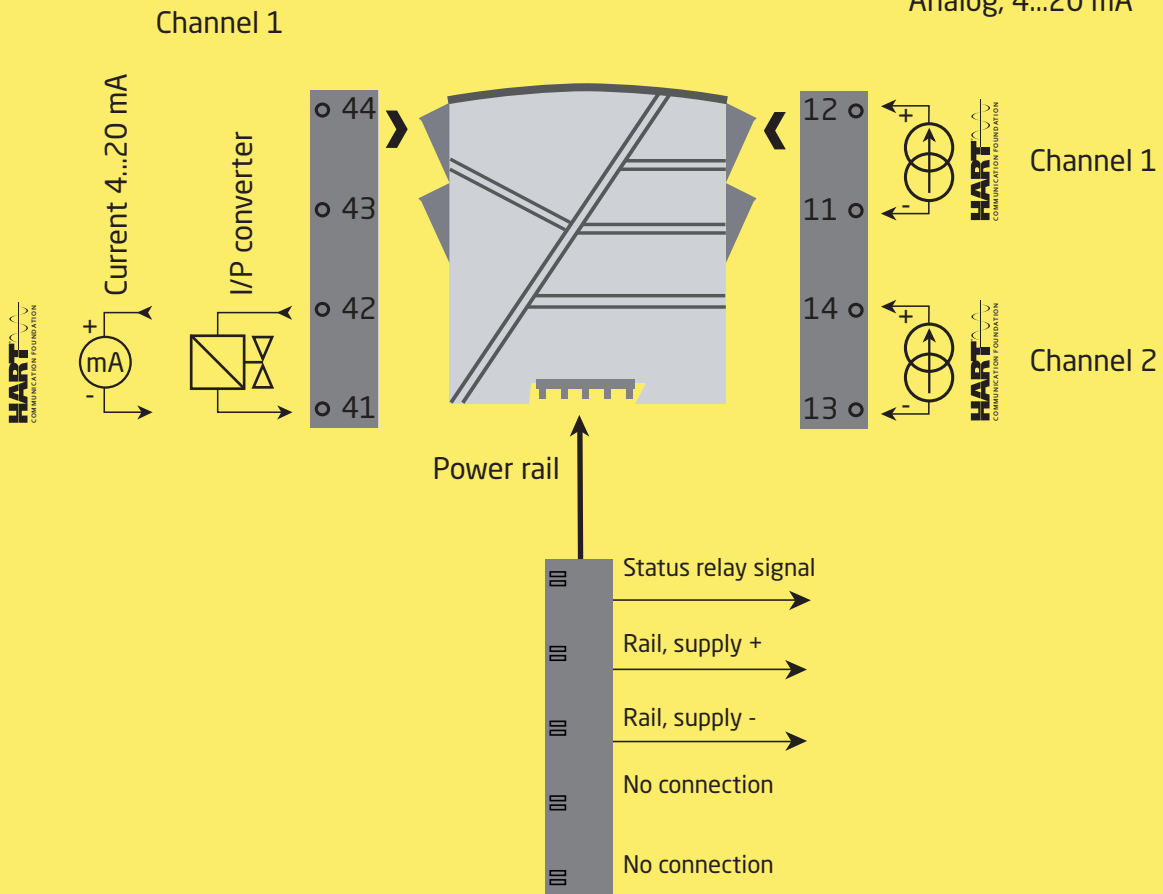

Channel 2

Power connection:

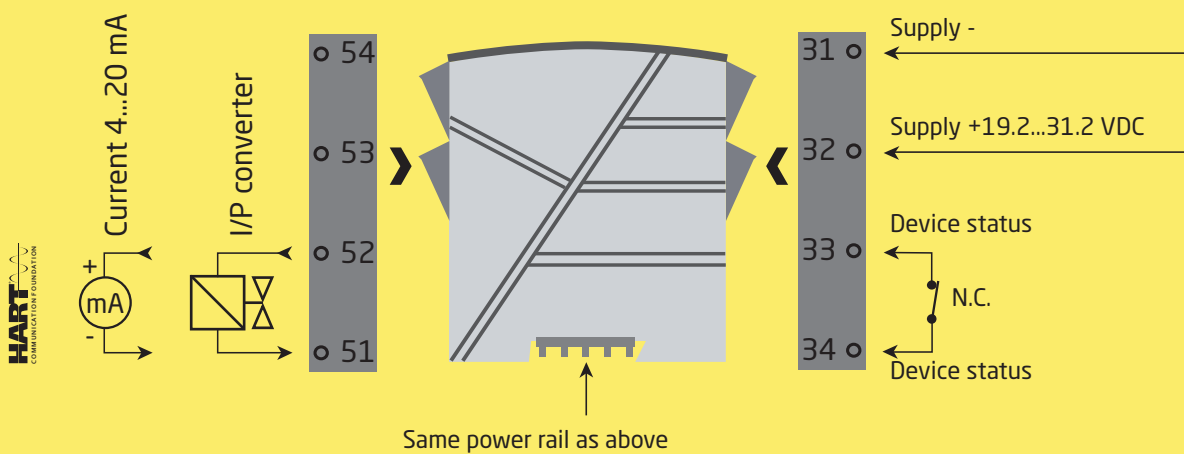

**Zone 2 & Cl. 1, Div. 2, gr. A-D  
or Safe Area**





# Applications - 9107Bxx

Output signals:

Input signals:

Analog, 4...20 mA

Channel 1

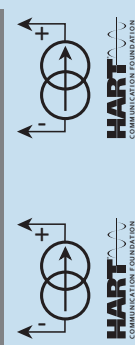
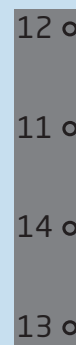
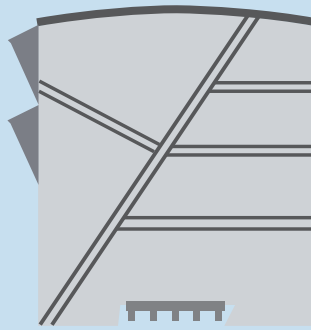
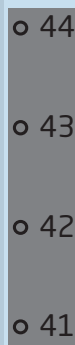
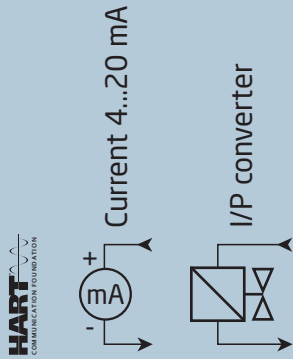

Channel 1

Channel 2

Power rail

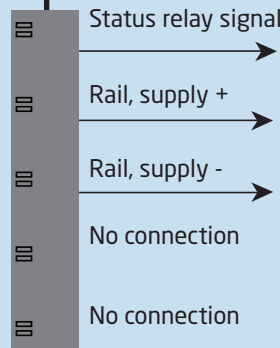

Channel 2

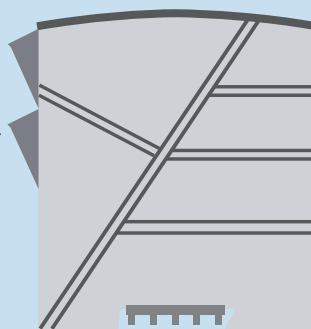
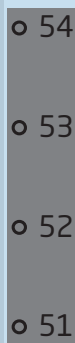
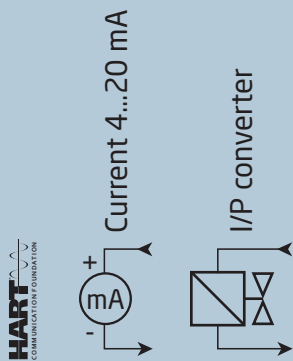

Power connection:

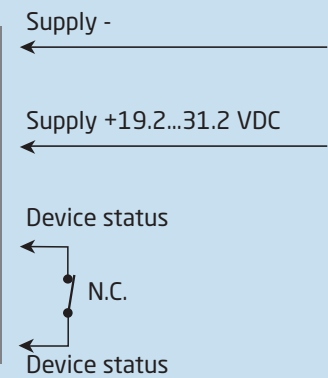

**Zone 0, 1, 2,  
20, 21, 22, M1 &  
Cl. I/II/III, Div. 1  
gr. A-G**

Same power rail as above

**Zone 2 & Cl. 1, Div. 2, gr. A-D  
or Safe Area**

## Order

Type	Associated apparatus	Unit channels	I.S. / Ex approvals
9107	No : A	Single : A	ATEX, IECEX, FM, : - INMETRO, CCC, EAC-Ex, UKEX
	Yes : B	Double : B	UL 913, ATEX, IECEX, FM, : -U9 INMETRO, CCC, EAC-Ex, UKEX KCs, ATEX, IECEX, FM, : -KCs INMETRO, CCC, EAC-Ex, UKEX

Example: 9107BB

## Accessories

4510	=	Display / programming front
4511	=	Modbus communication enabler
4512	=	Bluetooth communication enabler
9400	=	Power rail
9404	=	Module stop for rail
9410	=	Power control unit
9421	=	Power supply 24 V - Ex ec nC

## Technical data

### Environmental conditions

Specifications range	-20°C to +60°C
Storage temperature	-20°C to +85°C
Calibration temperature	20...28°C
Relative humidity	< 95% RH (non-cond.)
Protection degree	IP20
Installation in	Pollution degree 2 & overvoltage category II.

### Mechanical specifications

Dimensions (HxWxD)	109 x 23.5 x 104 mm
Dimensions (HxWxD) w/ PR 4500	109 x 23.5 x 131 mm
Weight approx.	250 g
DIN rail type	DIN EN 60715 - 35 mm
Wire size	0.13...2.08 mm <sup>2</sup> / AWG 26...14 stranded wire
Screw terminal torque	0.5 Nm
Vibration	IEC 60068-2-6
2...13.2 Hz	±1 mm
13.2...100 Hz	±0.7 g

### Common electrical specifications

Supply voltage	19.2...31.2 VDC
Fuse	1.25 A SB / 250 VAC

Type	Description	Max. power dissipation	Max. required power
9107xAx	1 channel	≤ 1.0 W	≤ 1.0 W
9107xBx	2 channels	≤ 1.8 W	≤ 1.8 W

Max. required power is the maximum power needed at terminals 31 and 32.

Max. power dissipation is the maximum power dissipated by the device.

If the 9107 is used with the PR 4500, then add 40 mW to the max. power dissipation and 70 mW to the max. required power for each device with the PR 4500.

Isolation - test / working:

- Input to any. . . . . 2.6 kVAC / 300 VAC reinforced isolation
- Analog output to supply . . . . . 2.6 kVAC / 300 VAC reinforced isolation
- Status relay to supply . . . . . 1.5 kVAC / 150 VAC reinforced isolation
- Programming . . . . . PR 4500
- Signal dynamics, input /output . . . . . Analog signal chain
- HART bi-directional communication frequency range . . . . . 0.5...7.5 kHz
- Signal / noise ratio. . . . . > 60 dB
- Response time (0...90%, 100...10%) . . . . . < 5 ms
- Effect of supply voltage change on output (nom. 24 VDC) . . . . . < ±10 µA

Accuracy values		
Input type	Absolute accuracy	Temperature coefficient
mA	≤ ±16 µA	≤ ±1.6 µA / °C

EMC - immunity influence. . . . .	< ±0.5% of span
Extended EMC immunity: NAMUR NE 21, A criterion, burst . . . . .	< ±1% of span

**Current input**

- Measurement range . . . . . 3.5...23 mA
- Sensor error detection:

  - Loop break 4...20 mA . . . . . < 1 mA

- Input voltage drop:

  - Supplied unit . . . . . < 2 V @ 23 mA
  - Non-supplied unit . . . . . < 4 V @ 23 mA

**Ex barrier data**

- Uo. . . . . 28 V
- Io . . . . . 93 mA
- Po. . . . . 0.65 W

**Current output**

- Signal range. . . . . 3.5...23 mA
- Load . . . . . ≤ 725 Ω
- Load stability . . . . . ≤ 0.01% of span / 100 Ω
- Current limit. . . . . ≤ 28 mA

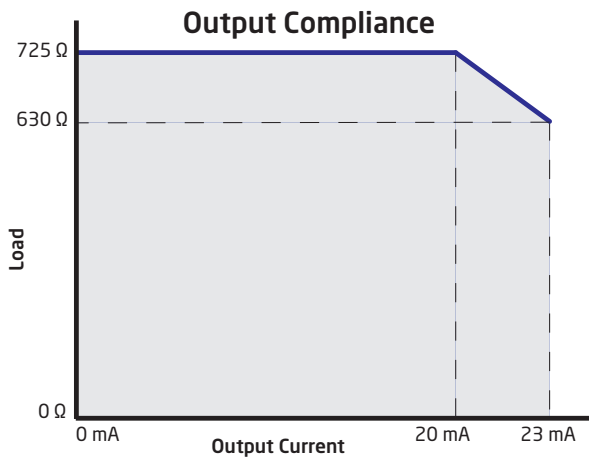

of span = normal measurement range 4...20 mA

## Status relay output terminal 33-34

Relay function . . . . .	N.C.
Programmable low setpoint . . . . .	0...29.9 mA
Programmable high setpoint . . . . .	0...29.9 mA
Hysteresis for setpoints . . . . .	0.1 mA
Max. voltage . . . . .	110 VDC / 125 VAC
Max. current. . . . .	0.3 ADC / 0.5 AAC
Max. voltage - hazardous installation. . . . .	32 VDC / 32 VAC
Max. current - hazardous installation. . . . .	1 ADC / 0.5 AAC

## Observed authority requirements

EMC. . . . .	2014/30/EU & UK SI 2016/1091
ATEX . . . . .	2014/34/EU & UK SI 2016/1107
LVD . . . . .	2014/35/EU & UK SI 2016/1101
RoHS . . . . .	2011/65/EU & UK SI 2012/3032

## Approvals

DNV, Ships & Offshore. . . . .	TAA00000JD
ClassNK . . . . .	TA24034M
c UL us, UL 61010-1. . . . .	E314307
EAC LVD . . . . .	TR-CU 004/2011
EAC . . . . .	TR-CU 020/2011
EAC Ex . . . . .	TR-CU 012/2011

## I.S. / Ex approvals

ATEX . . . . .	DEKRA 11ATEX0247X
IECEX. . . . .	IECEX DEK 11.0088X
UKEX. . . . .	DEKRA 21UKEX0173 X / DEKRA *22UKEXYYYY X
c FM us. . . . .	FM16US0465X / FM16CA0213X
INMETRO . . . . .	DEKRA 16.0002 X
c UL us, UL 913 (only 9107xx-U9) . . . . .	E233311
CCC . . . . .	2020322304003422
KCs (only 9107xx-KCs) . . . . .	21-AV4BO-0170X / 21-AV4BO-0171X / 21-AV4BO-0172X
EAC Ex . . . . .	RU C-DK.HA65.B.00355/19

## Functional Safety

SIL2 Certified & Fully Assessed acc. to IEC 61508  
SFF > 60% - type A component

\* Pending

## Visualisation in the PR 4500 of hardware / software error

Readout at hardware error		
Error search	Readout	Cause
Communications test PR 4500 and 9107	NO.CO	Connection error
EEprom error - check configuration	FL.ER	Configuration error or CRC mismatch, recovery configuration is loaded
User error	II!/II!	Loop limit exceeded
User error	II!/II!	Loop error
EEprom error - check configuration	EE.ER / IE.ER	Invalid configuration (CRC or data)
Hardware error	SU.ER	Supply error
Hardware error	RA.ER	RAM error
Hardware error	FL.ER	Flash error
Hardware error	IN.ER	Initialization error
Hardware error	C1.ER	Hardware error - channel 1
Hardware error	C2.ER	Hardware error - channel 2
Hardware error	DE.ER	General error

! All error indications in the display flash once per second. The help text explains the error.  
In case of cable fault the backlight also flashes. This can be reset by pressing the  key.

Errors affecting both channels are shown as error on channel 1 - and the line showing channel 2 is blank.

Hardware error can be reset in two ways. Either step through the menus (if the other channel is to stay in operation) or power cycle the device.

## Connections

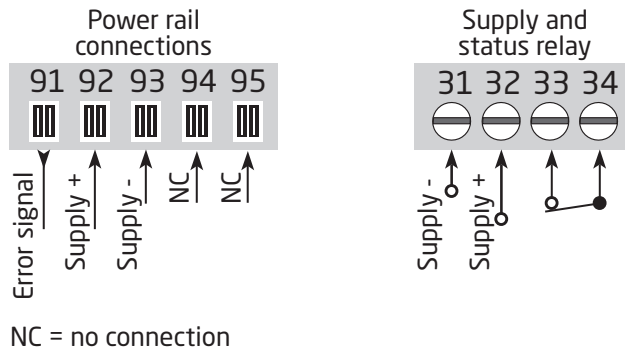

## Outputs:

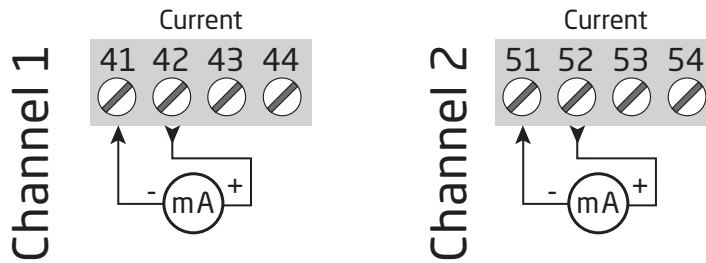

## Inputs:

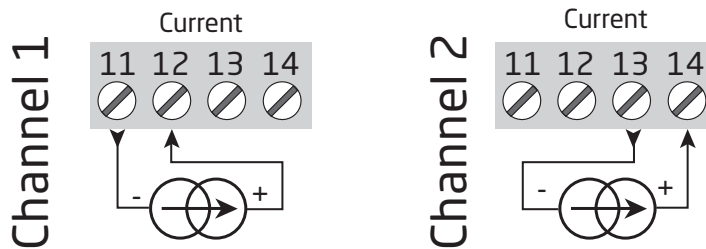

HART communication is possible directly on the input and output terminals if the output load impedance is  $> 250 \text{ Ohm}$  &  $< 725 \text{ Ohm}$  or if the input loop resistance is higher than  $250 \text{ Ohm}$ .

# Block diagram

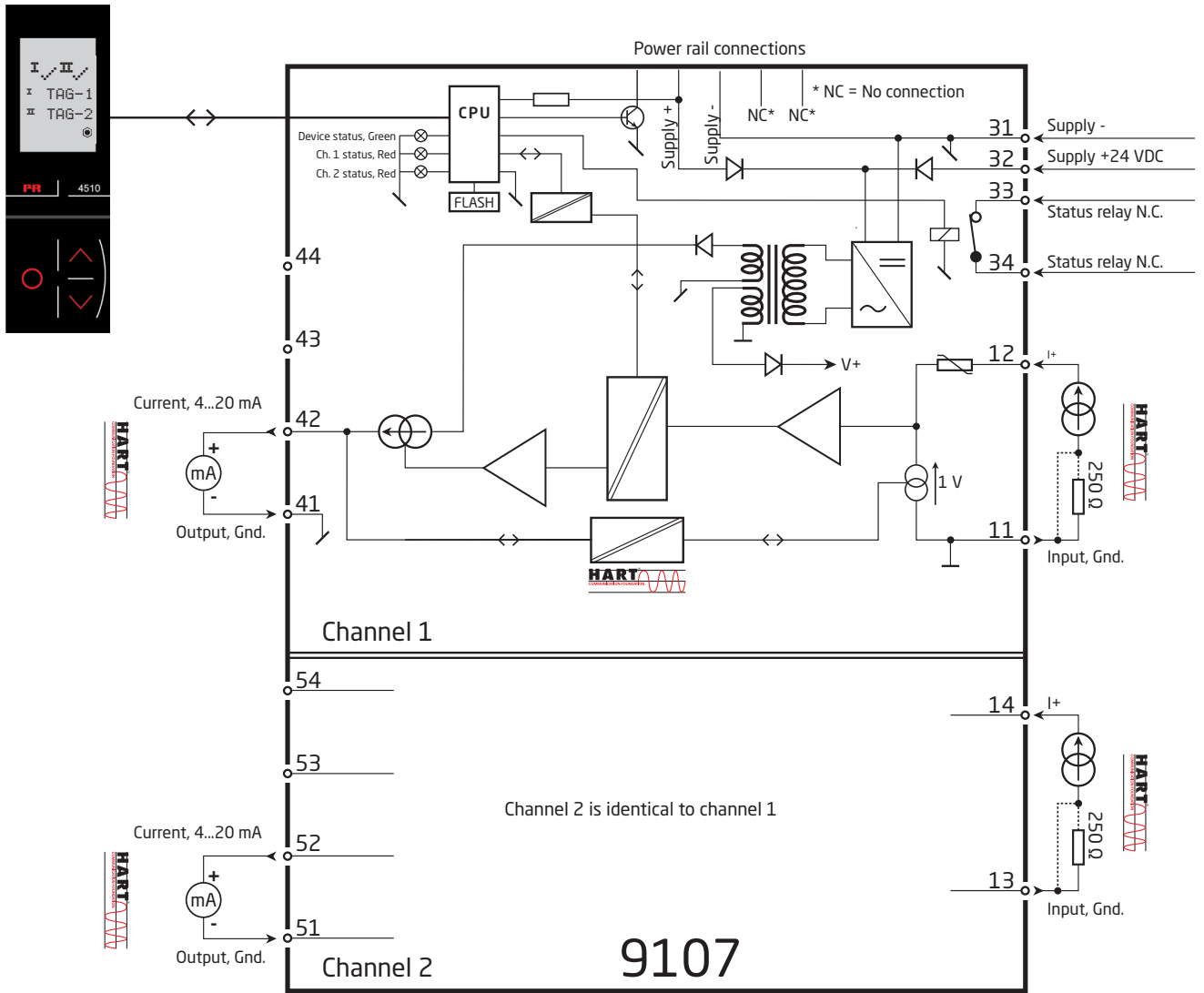

## Signal error indications without display front

List of LED and error signal indications					
Condition	Green LED	Ch. 1: Red	Ch. 2: Red	Status relay, N.C.	Power rail signal status
Device OK	Blinking	OFF	OFF	Energized	OFF
No supply	OFF	OFF	OFF	De-energized	ON
Device defective	Blinking	ON	ON	De-energized	ON
Ch. 1 defective (ch. 2 OK)	Blinking	ON	OFF	De-energized	ON
Ch. 2 defective (ch. 1 OK)	Blinking	OFF	ON	De-energized	ON
Channel 1, signal OK	Blinking	OFF	OFF	Energized	OFF
Ch. 1, signal limit exceeded	Blinking	Blinking	OFF	De-energized	ON (if activated)
Ch. 1, fixed loop break limit exceeded	Blinking	Flashing	OFF	De-energized	ON (if activated)
Channel 2, signal OK	Blinking	OFF	OFF	Energized	OFF
Ch. 2, signal limit exceeded	Blinking	OFF	Blinking	De-energized	ON (if activated)
Ch. 2, fixed loop break limit exceeded	Blinking	OFF	Flashing	De-energized	ON (if activated)

Blinking : 50% ON and 50% OFF 

Flashing : 8% ON and 92% OFF 



# Configuration / operating the function keys

Documentation for routing diagram.

## In general

When configuring the 9107, you will be guided through all parameters and you can choose the settings which fit the application. For each menu there is a scrolling help text which is automatically shown in line 3 on the display.

Configuration is carried out by use of the 3 function keys:

- ⏪ will increase the numerical value or choose the next parameter
- ⏩ will decrease the numerical value or choose the previous parameter
- ⏹ will save the chosen value and proceed to the next menu

When configuration is completed, the display will return to the default state 1.0. Pressing and holding ⏹ will return to the previous menu or return to the default state (1.0) without saving the changed values or parameters.

If no key is activated for 1 minute, the display will return to the default state (1.0) without saving the changed values or parameters.

## Further explanations

**Password protection:** Programming access can be blocked by assigning a password. The password is saved in the device in order to ensure a high degree of protection against unauthorized modifications to the configuration.

If the configured password is not known, please contact PR electronics support - [www.prelectronics.com/contact](http://www.prelectronics.com/contact).

## Loop limits

In the menus LO.LIM and HI.LIM you can choose the current values which will trigger a loop error alarm from the status relay. The NAMUR NE43 limits are selected by setting LO.LIM at 3.6 mA and HI.LIM at 21 mA. The selected limits are identical for both channels. This function can be deactivated by selecting limits outside the range 3.5...23 mA. Alternatively, the status relay can be used as a simple limit switch in the 1-channel version.

The loop break limit is fixed  $\leq 1$  mA. If this limit is exceeded, the status relay will be de-energized.

## Signal and sensor error indication via display front PR 4500

Sensor error (loop break) is shown in line 1 on the display by flashing  $\text{!}$  and  $\text{!}$ . The actual mA value is also shown followed by an explanatory text. Channel 1 is shown in line 2 and channel 2 is shown in line 3 on the display.

Line 4 on the display shows the condition of the COM (flashing bullet) indicating correct functioning of PR 4500.

## Advanced functions

The unit gives access to a number of advanced functions which can be reached by answering "Yes" to the point "ADV.SET".

**Display setup:** Here you can adjust the brightness contrast and the backlight. Setup of tag numbers with 5 alphanumerics. Selection of functional readout in line 2 and 3 on the display - choose between readout of loop current or tag no. When selecting "ALT" the readout toggles between loop current and tag no.

**Password:** Here you can choose a password between 0000 and 9999 in order to protect the unit against unauthorised modifications to the configuration. The unit is delivered default without password.

**Language:** In the menu "LANG" you can choose between 7 different language versions of help texts that will appear in the menu. You can choose between UK, DE, FR, IT, ES, SE and DK.

**Power rail:** In the menu "RAIL" you can choose if a signal is transmitted to the central surveillance in the PR 9410 power control unit when the signal limits are exceeded.

**Safety Integrity Level (SIL):** See Safety Manual for details.



# Routing diagram

If no key is activated for 1 minute, the display will return to the default state 1.0 without saving configuration changes.

⬆ Increase value / choose next parameter

⬇ Decrease value / choose previous parameter

⊙ Save the chosen value and proceed to the next menu

Hold ⊙ Back to previous menu / return to menu 1.0 without saving.

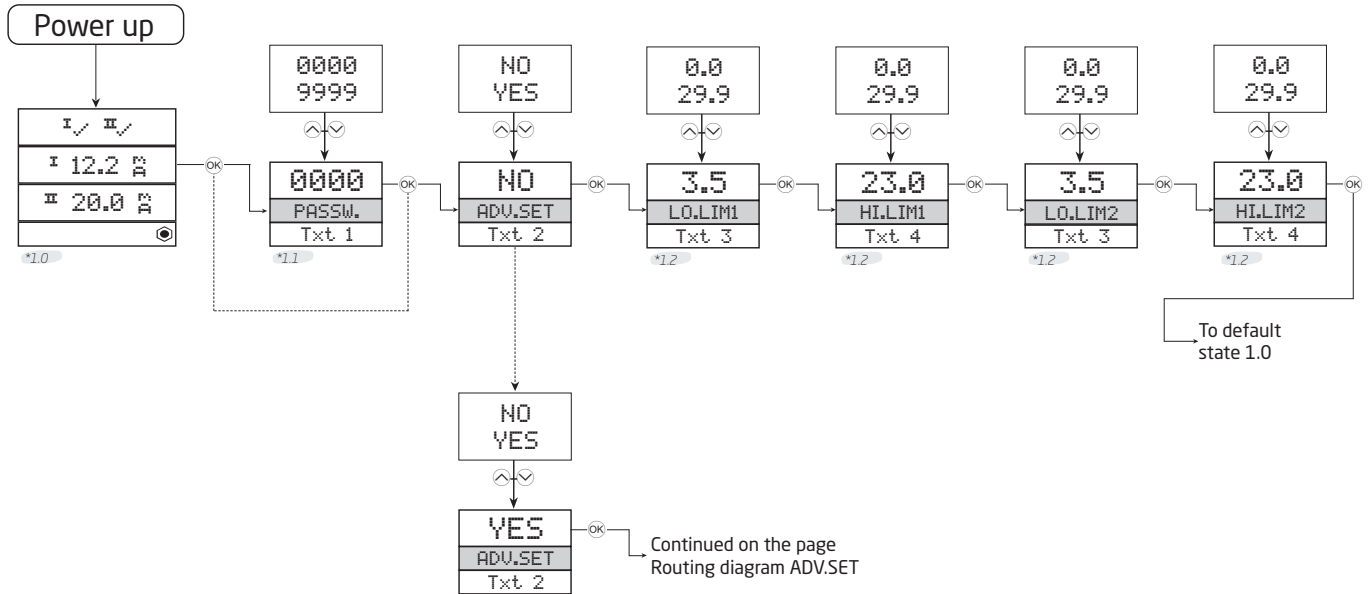

\*1.0 Default state.  
 Line 1 shows status for channel 1 and channel 2  
 Line 2 shows analog value or tag no. for channel 1.  
 If the loop limit is exceeded (LO.LIM and HI.LIM) the analog value is shown for 5 s followed by txt 18.  
 In case of loop break, 0.0 is shown for 5 s. followed by txt 19.  
 Line 3 shows the same as line 2, only for channel 2.  
 Line 4 shows status for communication.

\*1.1 Only if password-protected.

\*1.2 Loop current limits (identical for both channels) can be deactivated by selecting values outside the range 3.5...23 mA.

Line 1 symbols:  
 ✎ = OK. Flashing ✎! = error.

# Routing diagram, advanced settings (ADV.SET)

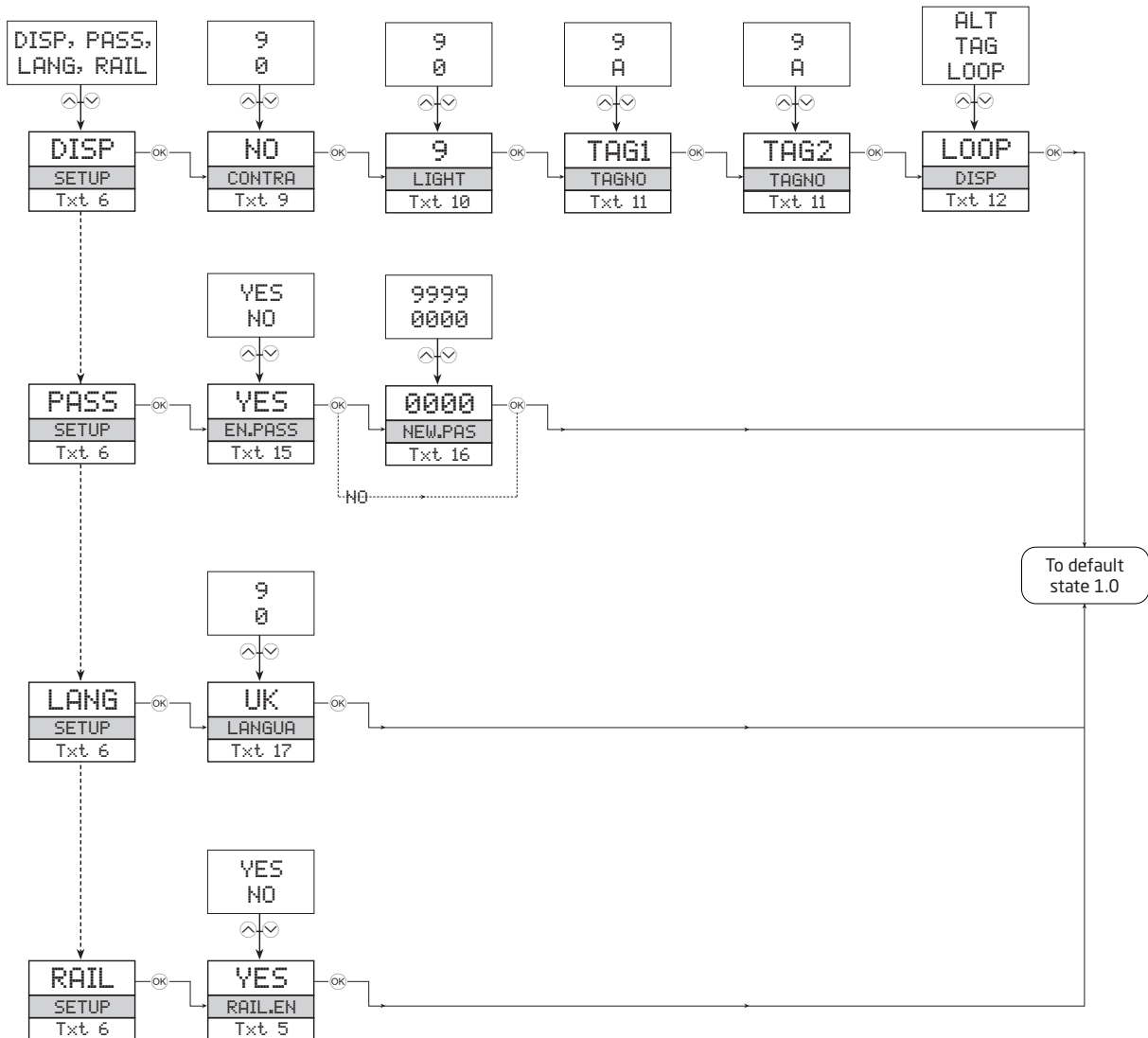

## Help text overview

- [01] Set correct password [PASS]
- [02] Enter advanced setup [ADV.SET]
- [03] Set low limit for loop error detection [LO.LIM1] [LO.LIM2]
- [04] Set high limit for loop error detection [HI.LIM1] [HI.LIM2]
- [05] Enable rail status signal output? [RAIL.ER]
- [06] Enter display setup [SETUP]
  - Enter password setup [SETUP]
  - Enter language setup [SETUP]
  - Enter rail setup [SETUP]
- [09] Adjust LCD contrast [CONTRA]
- [10] Adjust LCD backlight [LIGHT]
- [11] Write a 5-character tag no. [TAGNO1] [TAGNO2]
- [12] Show loop values in display
  - Show Tag no. in display
  - Alternate shown information in display
- [15] Enable password protection [EN.PASS]
- [16] Set new password [NEW.PAS]
- [17] Select language [LANGUA]
- [18] Loop signal limit exceeded
- [19] Loop wire breakage
- [20] No communication - check connections
- [21] Eeprom error - check configuration
- [22] Hardware error

LERBAKKEN 10, 8410 RØNDE DENMARK

## IECEX Installation drawing



For safe installation of 9107 the following must be observed. The module shall only be installed by qualified personnel who are familiar with the national and international laws, directives and standards that apply to this area.  
Year of manufacture can be taken from the first two digits in the serial number.



For Installation in Zone 2 the following must be observed.  
The 4501 programming module is to be used solely with PRelectronics modules. It is important that the module is undamaged and has not been altered or modified in any way. Only 4501 modules free of dust and moisture shall be installed.

9107BA: 1 channel HART® -transparent driver  
9107BB: 2 channel HART® -transparent driver

**IECEX Certificate:** ..... IECEX DEK 11.0088X  
Marking 9107Bx [Ex ia Ga] IIC/IIB/IIA  
[Ex ia Da] IIIC  
[Ex ia Ma] I

Marking 9107Bx, 9107Ax Ex ec nC IIC T4 Gc

**Standards** IEC60079-11:2011, IEC60079-0: 2017, IEC60079-15 :2017  
IEC60079-7: 2015+A1:2017

### Supply terminal (31,32)

Voltage: 19.2 – 31.2 VDC

### Status Relay. terminal (33,34)

		<b>Zone 2 Installation</b>
Voltage max:	125 VAC / 110 VDC	32 VAC / 32 VDC
Power max:	62.5 VA / 32 W	16 VA / 32 W
Current max:	0.5 AAC / 0.3 ADC	0.5 AAC / 1 ADC

### Installation notes:

Install in pollution degree 2, overvoltage category II as defined in IEC 60664-1.

Do not separate connectors when energized and an explosive gas mixture is present.  
Do not mount or remove modules from the Power Rail when an explosive gas mixture is present.  
Disconnect power before servicing.  
The wiring of unused terminals is not allowed.

In type of protection [Ex ia Da] the parameters for intrinsic safety for gas group IIB are applicable.

For installation in Zone 2, the module shall be installed in an enclosure in type of protection Ex n or Ex e, providing a degree of protection of at least IP54. Cable entry devices and blanking elements shall fulfill the same requirements.

For installation on Power Rail in Zone 2, only Power Rail type 9400 supplied by Power Control Unit type 9410 (Type Examination Certificate KEMA 07ATEX0152) is allowed.

LERBAKKEN 10, 8410 RØNDE DENMARK

**Hazardous area**

Zone 0,1,2, 20, 21, 22

**Non Hazardous area**

or Zone 2

(terminal 11,12,13,14)  
(terminal 31,32,33,34)  
(terminal 91,92,93,94,95)  
Um: 253 V, max 400 Hz

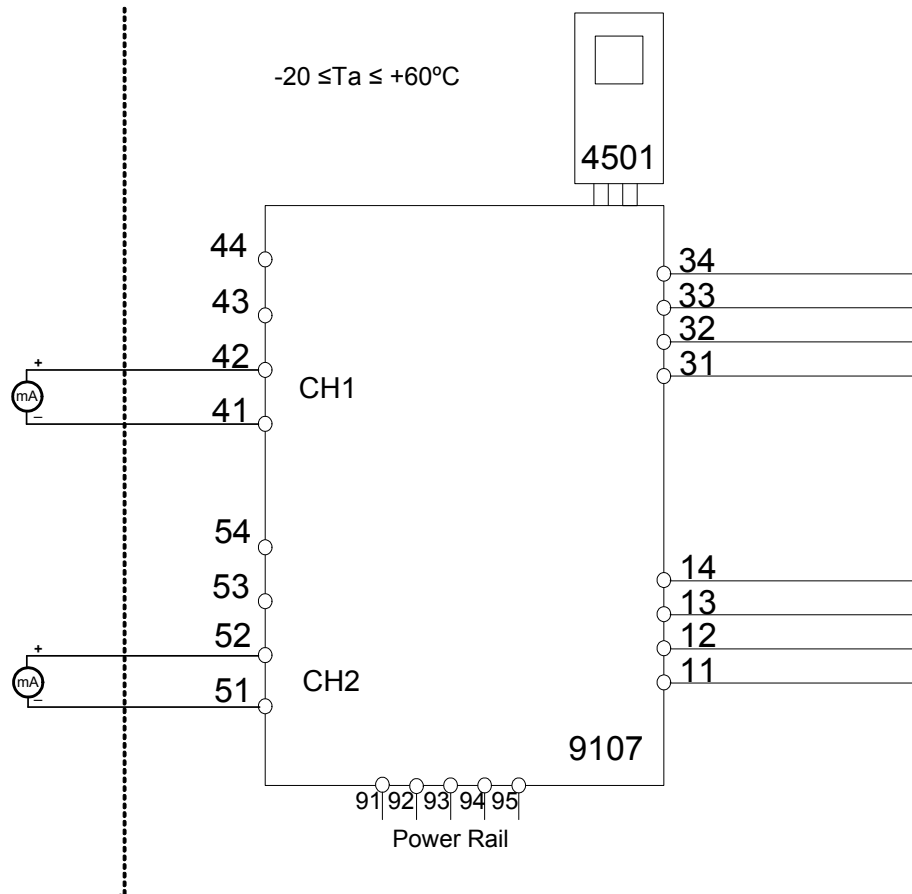

**CH1 (terminal 41,42)**

**CH2 (terminal 51,52)**

U<sub>o</sub>: 28 V  
I<sub>o</sub>: 93 mA  
P<sub>o</sub>: 0.65 W

	IIC	IIB	IIA	I
C <sub>o</sub> .	0.080 μF	0.650 μF	2.15 μF	3.76 μF
L <sub>o</sub> .	4 mH	16 mH	32 mH	35 mH

LERBAKKEN 10, 8410 RØNDE DENMARK

**9107Ax, 9107Bx Installation:**

Hazardous area  
Zone 2

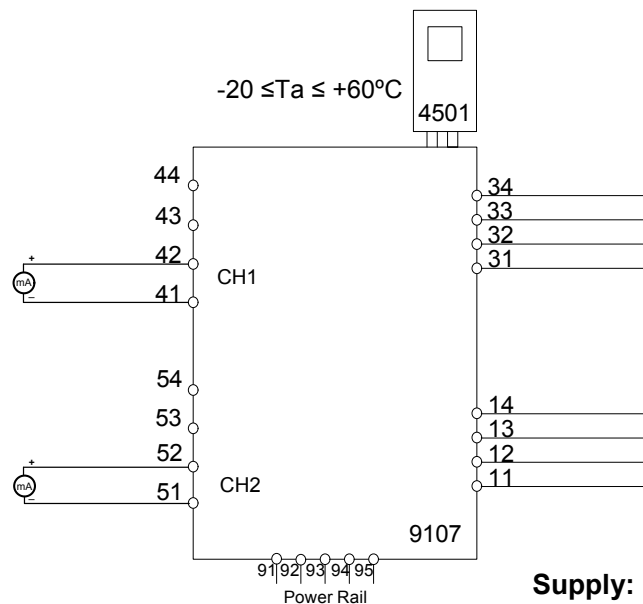

**Supply: 19.2 – 31.2 VDC**  
**(terminal 31,32)**  
**(terminal 91,92,93,94,95)**

**Output**  
**CH1 (terminal 41,42)**  
**CH2 (terminal 51,52)**

**Input:**  
**(terminal 11,12,13,14)**

**Status Relay. terminal (33,34)**

Voltage max: 125 VAC / 110 VDC  
Power max: 62.5 VA / 32 W  
Current max: 0.5 AAC / 0.3 ADC

**Zone 2 Installation**

32 VAC / 32 VDC  
16 VA / 32 W  
0.5 AAC / 1 ADC

For installation in Zone 2, the module shall be installed in an enclosure in type of protection Ex n or Ex e, providing a degree of protection of at least IP54. Cable entry devices and blanking elements shall fulfill the same requirements.

For installation on Power Rail in Zone 2, only Power Rail type 9400 supplied by Power Control Unit type 9410 (Certificate IECEx KEM 08.0025X) is allowed.

For Installation in Zone 2 the following must be observed. The 4501 programming module is to be used solely with PRelectronics modules. It is important that the module is undamaged and has not been altered or modified in any way. Only 4501 modules free of dust and moisture shall be installed.

LERBAKKEN 10, 8410 RØNDE DENMARK

## ATEX/UKEX Installation drawing



For safe installation of 9107 the following must be observed. The module shall only be installed by qualified personnel who are familiar with the national and international laws, directives and standards that apply to this area.

Year of manufacture can be taken from the first two digits in the serial number.



For Installation in Zone 2 the following must be observed.

The 4501 programming module is to be used solely with PR electronics modules. It is important that the module is undamaged and has not been altered or modified in any way.

Only 4501 modules free of dust and moisture shall be installed.

**ATEX Certificate:**
**UKEX Certificate, 9107Bxx**
**UKEX Certificate, 9107Axx, 9107Bxx**

DEKRA 11 ATEX0247X

 DEKRA 22UKEXYYYY X - *Pending*

DEKRA 21UKEX0173 X

**Marking 9107Bx**

II (1) G [Ex ia Ga] IIC/IIB/IIA

II (1) D [Ex ia Da] IIIC

I (M1) [Ex ia Ma] I

**Marking 9107Ax, 9107Bx**

II 3 G Ex ec nC IIC T4 Gc

**Standards:**

EN 60079-0 : 2018, EN 60079-11 : 2012,

EN 60079-15 : 2019,

EN 60079-7 : 2015+A1:2018

**Supply terminal (31,32)**

Voltage :

19.2 – 31.2 VDC

**Status Relay. terminal (33,34)**

Voltage max:

125 VAC / 110 VDC

Power max:

62.5 VA / 32 W

Current max:

0.5A AC / 0.3 ADC

**Zone 2 Installation**

32 VAC / 32 VDC

16 VA / 32 W

0.5 AAC / 1 ADC

**Specific Conditions of Use**

Install in pollution degree 2, overvoltage category II as defined in EN 60664-1.

Do not separate connectors when energized and an explosive gas mixture is present.

Do not mount or remove modules from the Power Rail when an explosive gas mixture is present.

Disconnect power before servicing.

The wiring of unused terminals is not allowed.

In type of protection [Ex ia Da] the parameters for intrinsic safety for gas group IIB are applicable.

For installation in Zone 2, the module shall be installed in an enclosure in type of protection Ex e, providing a degree of protection of at least IP54. Cable entry devices and blanking elements shall fulfill the same requirements.

Revision date:

2022-08-19

Version Revision

V5 R0

Prepared by:

MMA

Page:

1/4



---

LERBAKKEN 10, 8410 RØNDE DENMARK

For installation on Power Rail in Zone 2, only Power Rail type 9400 supplied by Power Control Unit type 9410 (Type Examination Certificate KEMA 07ATEX0152 X, DEKRA 21UKEX0169 X) is allowed.

Max. screw terminal torque 0.5 Nm.

Stranded wire should be installed with an insulation stripping length of 5 mm or via a suitable insulated terminal such as a bootlace ferrule.

LERBAKKEN 10, 8410 RØNDE DENMARK

Hazardous area  
Zone 0,1,2, 20, 21, 22

Non Hazardous area  
or Zone 2

(terminal 11,12,13,14)  
(terminal 31,32,33,34)  
(terminal 91,92,93,94,95)  
Um: 253 V, max 400 Hz

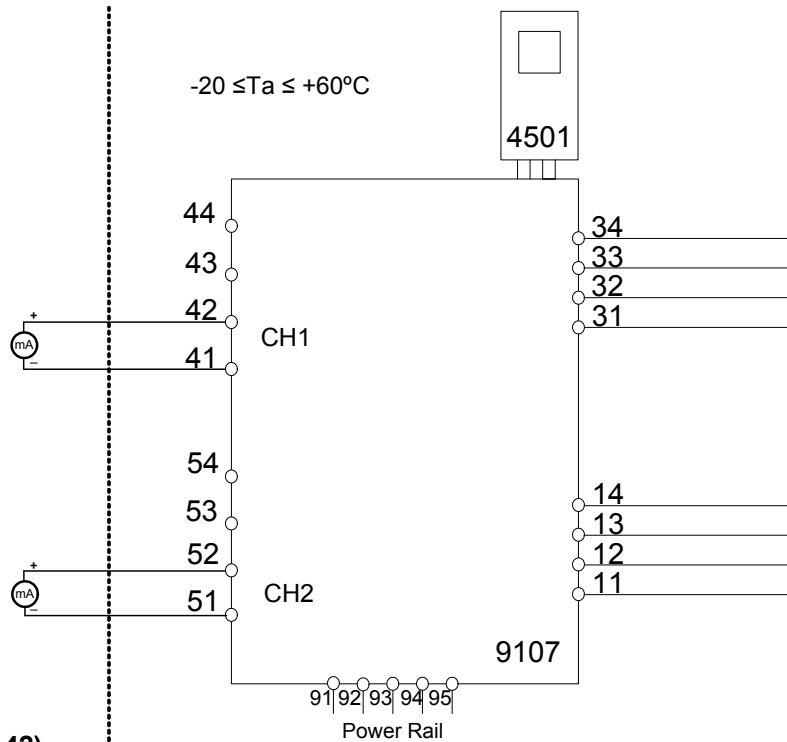

**CH1 (terminal 41,42)**  
**CH2 (terminal 51,52)**

U<sub>o</sub>: 28 V  
I<sub>o</sub>: 93 mA  
P<sub>o</sub>: 0.65 W

	IIC	IIB	IIA	I
C <sub>o</sub> .	0.080 μF	0.650 μF	2.15 μF	3.76 μF
L <sub>o</sub> .	4 mH	16 mH	32 mH	35 mH

LERBAKKEN 10, 8410 RØNDE DENMARK

**9107Bx, 9107Ax Installation:**

Hazardous area  
Zone 2

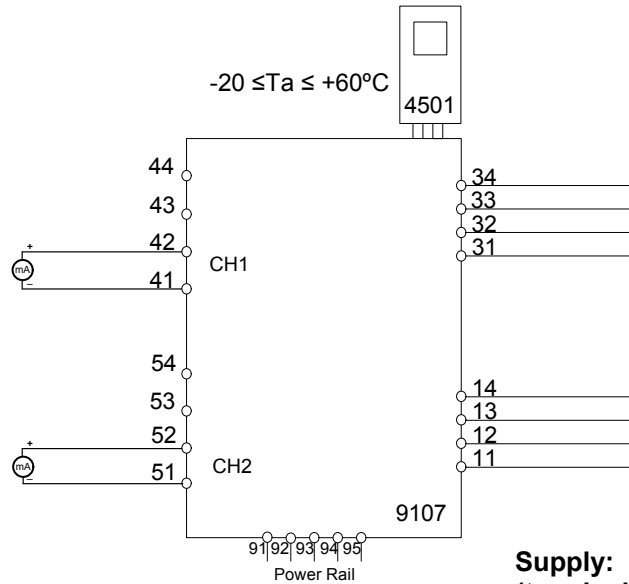

**Supply: 19.2 – 31.2 VDC**  
**(terminal 31,32)**  
**(terminal 91,92,93,94,95)**

**Output**  
**CH1 (terminal 41,42)**  
**CH2 (terminal 51,52)**

**Input:**  
**(terminal 11,12,13,14)**

**Status Relay. terminal (33,34)**

Voltage max:	125 VAC / 110 VDC
Power max:	62.5 VA / 32 W
Current max:	0.5 AAC / 0.3 ADC

**Zone 2 Installation**

32 VAC / 32 VDC
16 VA / 32 W
0.5 AAC / 1 ADC

For installation in Zone 2, the module shall be installed in an enclosure in type of protection Ex e, providing a degree of protection of at least IP54. Cable entry devices and blanking elements shall fulfill the same requirements.

For installation on Power Rail in Zone 2, only Power Rail type 9400 supplied by Power Control Unit type 9410 (Type Examination Certificate KEMA 07ATEX0152 X, DEKRA 21UKEX0169 X) is allowed.

For Installation in Zone 2 the following must be observed. The 4501 programming module is to be used solely with PR electronics modules. It is important that the module is undamaged and has not been altered or modified in any way. Only 4501 modules free of dust and moisture shall be installed.

LERBAKKEN 10, 8410 RØNDE DENMARK

## FM Installation drawing



For safe installation of 9107B the following must be observed. The module shall only be installed by qualified personnel who are familiar with the national and international laws, directives and standards that apply to this area.

Year of manufacture can be taken from the first two digits in the serial number.



For Installation in Zone 2 the following must be observed.

The 4501 programming module is to be used solely with PRelectronics modules. It is important that the module is undamaged and has not been altered or modified in any way. Only 4501 modules free of dust and moisture shall be installed.

9107BA: 1 channel **HART® -transparent driver**

9107BB: 2 channel **HART® -transparent driver**

### Supply terminal (31,32)

Voltage: 19.2 – 31.2 VDC

### Status Relay. terminal (33,34)

Voltage max: 125VAC / 110VDC

Power max: 62,5VA / 32W

Current max: 0.5A AC / 0.3ADC

Zone 2 installation:

Voltage max: 32VAC / 32VDC

Power max: 16VA / 32W

Current max: 0.5A AC / 1ADC

### Installation notes:

In Class I, Division 2 installations, the subject equipment shall be mounted within a too-secured enclosure which is capable of accepting one or more of the Class I, Division 2 wiring methods specified in the National Electrical Code (ANSI/NFPA 70) or Canadian Electrical Code (C22.1).

In Class I, Zone 2 installations, the subject equipment shall be mounted within a tool secured enclosure which is capable of accepting one or more of the Class I, Zone 2 wiring methods specified in the National Electrical Code (ANSI/NFPA 70) or Canadian Electrical Code (C22.1). Where installed in outdoor or potentially wet locations, the enclosure shall, at a minimum, meet the requirements of IP54.

Install in environments rated Pollution Degree 2 or better; overvoltage category I or II.

The equipment shall be installed in an enclosure with a minimum ingress protection rating of IP54 unless the apparatus is intended to be afforded an equivalent degree of protection by location.

The module is galvanically isolated and does not require grounding.

Use 60 / 75 °C copper conductors with wire size AWG: (26-14)

**Warning:** Substitution of components may impair intrinsic safety.

Revision date:  
2019-04-04

Version Revision  
V3 R0

Prepared by:  
PB

Page:  
1/2

LERBAKKEN 10, 8410 RØNDE DENMARK

**Warning:** To prevent ignition of the explosive atmospheres, disconnect power before servicing and do not separate connectors when energized and an explosive gas mixture is present.

**Warning:** Do not install or remove modules from the Power Rail when an explosive gas mixture is present.

**Hazardous Classified Location**

Class I/II/III, Division 1, Group A,B,C,D,E,F,G  
or Class I, Zone 0/1 Group IIC, [AEx ia] IIC  
or Group IIC, [Ex ia Ga] IIC Gc

**Unclassified Location or  
Hazardous Classified Location**

Class I, Division 2, Group A,B,C,D T4  
or Class I Zone 2 Group IIC T4 Gc

Simple Apparatus or  
Intrinsic safe apparatus  
with entity parameters:

$V_{max}(U_i) \geq V_t(U_o)$   
 $I_{max}(I_i) \geq I_t(I_o)$   
 $P_i \geq P_t(P_o)$   
 $C_a \geq C_{cable} + C_i$   
 $L_a \geq L_{cable} + L_i$

**CH1 (terminal 41,42)**

**CH2 (terminal 51,52)**

$U_o, V_{oc}: 28\text{ V}$   
 $I_o, I_{sc}: 93\text{ mA}$   
 $P_o: 0.65\text{ W}$

	IIC or A,B	IIB or C,E,F	IIA or D,G
$C_o$	0.08 $\mu\text{F}$	0.650 $\mu\text{F}$	2.15 $\mu\text{F}$
$L_o$	4 mH	16 mH	32 mH

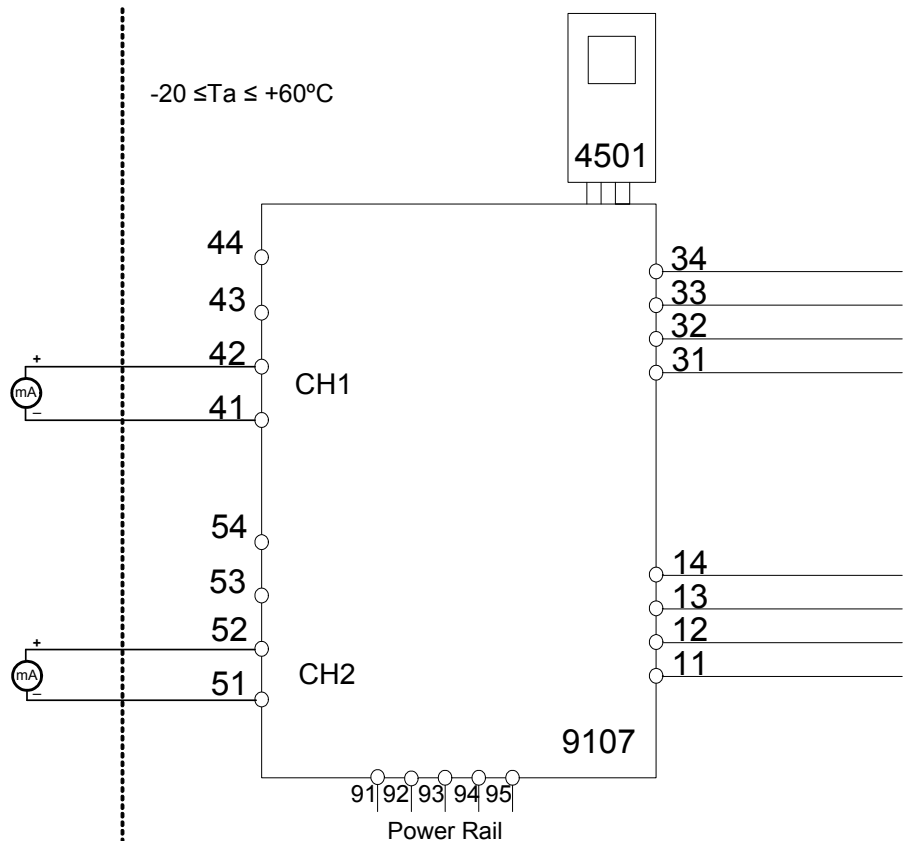

(terminal 11,12,13,14)  
(terminal 31,32,33,34)  
(terminal 91,92,93,94,95)  
 $U_m: 253\text{V, max } 400\text{Hz}$

LERBAKKEN 10, 8410 RØNDE DENMARK

## UL Installation drawing



For safe installation of the Process Control Equipment (Associated Apparatus) 9107 the following must be observed. The module shall only be installed by qualified personnel who are familiar with the national and international laws, directives and standards that apply to this area.



For Installation in Div2 / Zone2 the following must be observed.  
The 4501 programming module is to be used solely with PRelectronics modules. It is important that the module is undamaged and has not been altered or modified in any way. Only 4501 modules free of dust and moisture shall be installed.

9107AA-U9:	1 channel HART® -transparent driver
9107BA-U9:	1 channel HART® -transparent driver
9107AB-U9:	2 channel HART® -transparent driver
9107BB-U9:	2 channel HART® -transparent driver

### Marking:



Proc. Cont. Eq. for Use in Haz. Loc.  
Install in CL I DIV2 GP A-D T4 provide  
IS circuits to CL I-III DIV 1 GP A-G  
or CL I Zn2 Gp IIC T4 provides IS  
E233311 circuits for CL I Zn0 Gp IIC/Zn20 Gp IIIC  
Um=253V [Exia] Installation Drawing: 9107QU01

The 9107Bxx is galvanically isolating associated apparatus intended for installation in non-hazardous locations or Class I, Division 2, Groups A – D hazardous locations with intrinsically safe connections to Class I, II and III hazardous locations.



Proc. Cont. Eq. for Use in Haz. Loc.  
Install in CL I DIV2 GP A-D T4  
or CL I Zn2 Gp IIC T4  
E233311 Installation Drawing: 9107QU01

The 9107Axx equipment is intended for installation in non-hazardous locations or Class I, Division 2, Groups A – D or Zone 2 Group IIC hazardous locations.

### Standards:

- UL 121201 NONINCENDIVE ELECTRICAL EQUIPMENT FOR USE IN CLASS I AND II, DIVISION 2 AND CLASS III, DIVISIONS 1 AND 2 HAZARDOUS (CLASSIFIED) LOCATIONS Edition 9 - Revision Date 2018/08/31
- CSA C22.2 NO. 213 NONINCENDIVE ELECTRICAL EQUIPMENT FOR USE IN CLASS I AND II, DIVISION 2 AND CLASS III, DIVISIONS 1 AND 2 HAZARDOUS (CLASSIFIED) LOCATIONS- Edition 3 - Issue Date 2017/09/01
- UL 913 STANDARD FOR INTRINSICALLY SAFE APPARATUS AND ASSOCIATED APPARATUS FOR USE IN CLASS I, II, III, DIVISION 1, HAZARDOUS (CLASSIFIED) LOCATIONS- Edition 8 - Revision Date 2015/10/16
- CSA C22.2 NO. 60079-0 EXPLOSIVE ATMOSPHERES — PART 0: EQUIPMENT — GENERAL REQUIREMENTS- Edition 3 - Issue Date 2015/10/01
- CSA C22.2 NO. 60079-11:14 EXPLOSIVE ATMOSPHERES — PART 11: EQUIPMENT PROTECTION BY INTRINSIC SAFETY “I”- Edition 2 - Issue Date 2014/02/01

Revision date:  
2019-11-26

Version Revision  
V1 R0

Prepared by:  
PB

Page:  
1/5

LERBAKKEN 10, 8410 RØNDE DENMARK

**Installation notes 9107Ax and 9107Bx:**

The module must be installed in a tool-secured enclosure suitable for the application in accordance with the National Electrical Code (ANSI/NFPA 70) for installation in the United States, the Canadian Electrical Code for installations in Canada, or other local codes, as applicable.

The module is galvanically isolated and does not require grounding.

Terminal 41, 42, 43, 44 are internally connected to CH1.

Terminal 51, 52, 53, 54 are internally connected to CH2.

Install in pollution degree 2, overvoltage category II in accordance with IEC 60664-1.

Use minimum 75 °C copper conductors with wire size AWG: (26-14)

**Warning:** Substitution of components may impair intrinsic safety.

**Avertissement :** La substitution des composants peut nuire à la sécurité intrinsèque’.

There are no serviceable parts in the equipment and no component substitution is permitted

**Warning:** To prevent ignition of the explosive atmospheres, disconnect power before servicing and do not separate connectors, install or remove module from Power Rail when energized and an explosive gas mixture is present.

**Avertissement :** Pour éviter l’inflammation d’atmosphères explosibles, déconnectez l’alimentation avant les opérations d’entretien. Ne montez pas ou n’enlevez pas les connecteurs quand le module est sous tension et en présence d’un mélange de gaz. Ne montez pas ou n’enlevez pas les modules du rail d’alimentation en présence d’un mélange de gaz.

**Installation notes 9107Bxx:**

Associated Equipment /Appareillage Associé [Ex ia]

The Ex output current of this associated apparatus is limited by a resistor such that the output voltage-current plot is a straight line drawn between open-circuit voltage and short-circuit current.

Selected intrinsically safe equipment must be third party listed as intrinsically safe for the application, and have intrinsically safe entity parameters conforming with Table 1 below.

**TABLE 1:**

<u>I.S. Equipment</u>		<u>Associated Apparatus</u>
V max (or Ui)	≥	Voc or Vt (or Uo)
I max (or Ii)	≥	Isc or It (or Io)
P max, Pi	≥	Po
Ci + Ccable	≤	Ca (or Co)
Li + Lcable	≤	La (or Lo)

The module may also be connected to a simple apparatus as defined in Article 504.2 and installed and temperature classified in accordance with Article 504.10(D) of the National Electrical Code (ANSI/NFPA 70), or other local codes, as applicable.

Capacitance and inductance of the field wiring from the intrinsically safe equipment to the associated apparatus shall be calculated and must be included in the system calculations as shown in Table 1. Cable capacitance, Ccable, plus intrinsically safe equipment capacitance, Ci must be less than the marked

Revision date:  
2019-11-26

Version Revision  
V1 R0

Prepared by:  
PB

Page:  
2/5

---

LERBAKKEN 10, 8410 RØNDE DENMARK

capacitance, Ca (or Co), shown on any associated apparatus used. The same applies for inductance (Lcable, Li and La or Lo, respectively). Where the cable capacitance and inductance per foot are not known, the following values shall be used: Ccable = 60 pF/ft., Lcable = 0.2  $\mu$ H/ft.

Where multiple circuits extend from the same piece of associated apparatus, they must be installed in separate cables or in one cable having suitable insulation. Refer to Article 504.30(B) of the National Electrical Code (ANSI/NFPA 70) and Instrument Society of America Recommended Practice ISA RP12.06 for installing intrinsically safe equipment.

Intrinsically safe circuits must be wired and separated in accordance with Article 504.20 of the National Electrical Code (ANSI/NFPA 70) or other local codes, as applicable.

The module has not been evaluated for use in combination with another associated apparatus.

For installations in which both the Ci and Li of the intrinsically safe apparatus exceeds 1% of the Ca (or Co) and La (or Lo) parameters of the associated apparatus (excluding the cable), then 50% of Ca (or Co) and La (or Lo) parameters are applicable and shall not be exceeded. The reduced capacitance shall not be greater than 1  $\mu$ F for Groups C and/or D, and 600 nF for Groups A and B. The values of Ca (or Co) and La (or Lo) determined by this method shall not be exceeded by the sum of all of Ci plus cable capacitances and the sum of all of the Li plus cable inductances in the circuit respectively.



LERBAKKEN 10, 8410 RØNDE DENMARK

**9107Bx Installation:**

**Hazardous Classified Location**

Class I / II / III, Division 1, Group A,B,C,D,E,F,G  
Class I Zone 0 / 1 / 2 Group IIC, IIB, IIA or  
Zone 20 / 21

**Unclassified Location or  
Hazardous Classified Location**

Class I, Division 2 Group A,B,C,D T4  
Class I, Zone 2, Group IIC, IIB, IIA T4

Simple Apparatus or  
Intrinsic safe apparatus  
with entity parameters:

$V_{max}(U_i) \geq V_t(U_o)$   
 $I_{max}(I_i) \geq I_t(I_o)$   
 $P_i \geq P_t(P_o)$   
 $C_a \geq C_{cable} + C_i$   
 $L_a \geq L_{cable} + L_i$

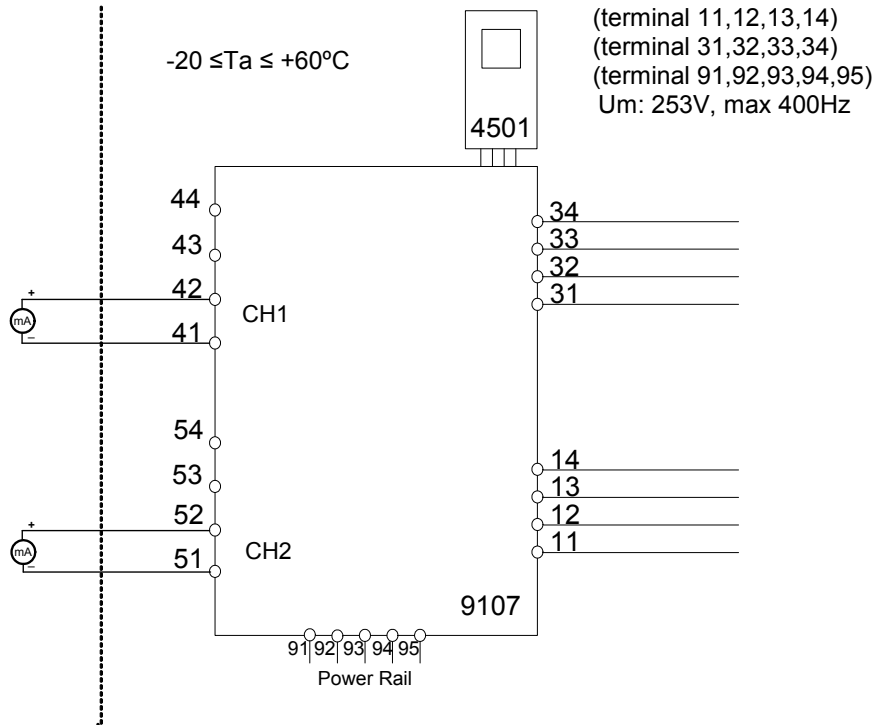

**CH1 (terminal 41,42)  
CH2 (terminal 51,52)**

Voc or U<sub>o</sub>: 28 Vdc  
Isc or I<sub>o</sub>: 93 mA  
P<sub>o</sub>: 0.65 W

	IIC or A,B	IIB or C,E,F	IIA or D,G
Ca or Co.	0.08μF	0.650μF	2.15 μF
La or Lo.	4 mH	16 mH	32 mH

**Supply terminal (31,32)**

Voltage: 19.2 – 31.2 VDC

**Status Relay.  
terminal (33,34)**

Voltage max:  
Current max:

**Class I Division 2 c  
Zone 2 installation**

32Vac / 32Vdc  
0.5Aac / 0.3Adc

LERBAKKEN 10, 8410 RØNDE DENMARK

**9107Ax and 9107Bx Installation:**

**Unclassified Location or  
Hazardous Classified Location**  
Class I, Division 2 Group A,B,C,D T4  
Class I, Zone 2, Group IIC, IIB, IIA T4

**Supply terminal (31,32)**  
Voltage: 19.2 – 31.2 VDC

**Status relay, terminal (33,34)**  
**Class I Division 2 or  
Zone 2 installation:**  
Voltage max: 32 Vac/ 32 Vdc  
Current max: 0.5 Aac / 0.3 Adc

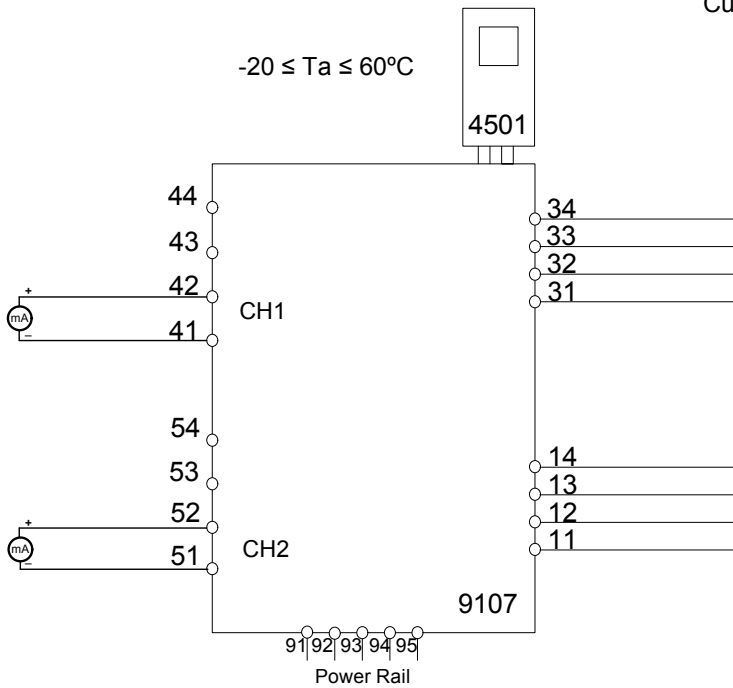

LERBAKKEN 10, 8410 RØNDE DENMARK

## INMETRO - Desenhos para Instalação



Para instalação segura do 9107B o manual seguinte deve ser observado. O módulo deve ser instalado somente por profissionais qualificados que estão familiarizados com as leis nacionais e internacionais, diretrizes e normas que se aplicam a esta área. Ano de fabricação pode ser obtido a partir dos dois primeiros dígitos do número de série.



Para a instalação na Zona 2 o seguinte deve ser observado. O módulo de programação de 4501, deve ser utilizado apenas com os módulos PRelectronics. É importante que o módulo esteja intacto e não tenha sido alterado ou modificado de qualquer maneira. Apenas os módulos 4501 livres de poeira e umidade devem ser instalados.

9107BA: 1 canal HART® - driver transparente  
9107BB: 2 canais HART® - driver transparente

**INMETRO Certificado ..... DEKRA 16.0002X**

**Marcas** [Ex ia Ga] IIC/IIB/IIA  
Ex nA nC IIC T4 Gc  
[Ex ia Da] IIIC  
[Ex ia Ma] I

**Normas:** ABNT NBR IEC 60079-0:2013, ABNT NBR IEC 60079-11:2013,  
ABNT NBR IEC 60079-15:2012

### Terminal de fonte de alimentação (31,32)

Voltagem: 19.2 – 31.2 VDC

### Relê de estado terminal (33,34)

		Instalação Zone 2
Voltagem máx.:	125 VAC / 110 VDC	32 VAC / 32 VDC
Potencia máx.:	62,5 VA / 32 W	16 VA / 32 W
Corrente máx.:	0,5 AAC / 0,3 ADC	0,5 AAC / 1 ADC

### Notas de instalação:

Instalação em grau de poluição 2, categoria de sobretensão II conforme definido no IEC 60664-1. Os circuitos não intrinsecamente seguros só pode ser connectado para sobretensão limitado ao categoria I/II como definido na IEC 60664-1

Não separe conectores quando energizado ou quando uma mistura de gás explosivo estiver presente.

Não monte ou remova módulos do trilho de alimentação quando uma mistura explosiva de gás estiver presente.

Desligue a alimentação antes da manutenção.

A fiação de terminais sem uso não é permitida.

Em tipo de proteção [Ex ia Da] os parâmetros para a segurança intrínseca para grupo de gás IIB são aplicáveis.

Para a instalação em Zona 2, o módulo deve ser instalado em um invólucro conformidade com o tipo de proteção 'Ex n' ou 'Ex e', fornecendo no mínimo grau de proteção IP54.

Dispositivos de entrada de cabo e elementos de vedação devem cumprir com os mesmos requisitos.

Para a instalação de trilho de energia na Zona 2, apenas o trilho de alimentação Rail 9400 fornecido pela Unidade de Controle de Potência 9410 é permitido.

LERBAKKEN 10, 8410 RØNDE DENMARK

**Área de classificada**  
Zona 0,1,2, 20, 21, 22

**Área de não classificada**  
ou Zona 2

(terminais: 11,12,13,14)  
(terminais: 31,32,33,34)  
(terminais: 91,92,93,94,95)  
Um: 253 V, máx. 400 Hz

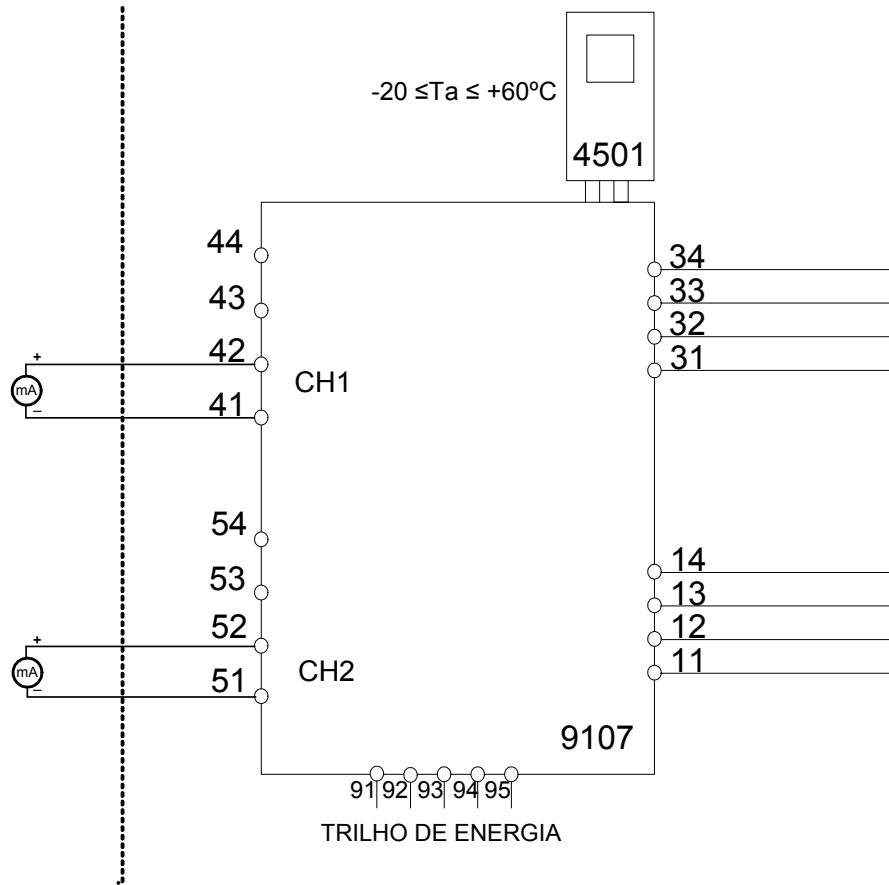

**CN1 (terminais 41,42)**

**CN2 (terminais 51,52)**

U<sub>o</sub>: 28 V

I<sub>o</sub>: 93 mA

P<sub>o</sub>: 0,65 W

	IIC	IIB	IIA	I
C <sub>o</sub> .	0,080 μF	0,650 μF	2,15 μF	3,76 μF
L <sub>o</sub> .	4 mH	16 mH	32 mH	35 mH

LERBAKKEN 10, 8410 RØNDE DENMARK

## IECEX 설치 도면



9107의 안전한 설치를 위해 다음 사항을 준수해야 합니다. 이 모듈은 이 지역에 적용되는 국내 및 국제 법률, 지침 및 표준에 정통한 유자격자만 설치해야 합니다.  
제조연도는 일련번호의 처음 두 자리입니다.



구역 2에 설치하려면 다음 사항을 준수해야 합니다.

4501 프로그래밍 모듈은 PR electronics 모듈과 함께만 사용해야 합니다. 모듈이 손상되지 않았고, 어떤 식으로든 변경 또는 수정되지 않는 것이 중요합니다. 먼지와 습기가 없는 상태에서 4501 모듈을 설치해야 합니다.

9107BA: 1채널 HART - 투명 드라이버  
9107BB: 2채널 HART - 투명 드라이버

**IECEX 인증서:** IECEx DEK 11.0088X  
**마킹 9107Bx** [Ex ia Ga] IIC/IIB/IIA  
[Ex ia Da] IIIC  
[Ex ia Ma]

**마킹 9107Bx, 9107Ax** Ex ec nC IIC T4 Gc

**표준** IEC60079-11:2011, IEC60079-0: 2017, IEC60079-15 :2017  
IEC60079-7: 2015+A1:2017

### 공급 단자(31,32)

전압: 19.2 – 31.2 VDC

### 상태 릴레이. 단자(33,34)

구역 2 설치

최대 전압: 125 VAC / 110 VDC

32 VAC / 32 VDC

최대 출력: 62.5 VA / 32 W

16 VA / 32 W

### 설치 참고 사항:

IEC 60664-1에 정의된 대로 오염 등급 2, 과전압 범주 II에 설치하십시오.

전원이 공급되고 폭발성 가스 혼합물이 있는 경우, 커넥터를 분리하지 마십시오.

폭발성 가스 혼합물이 있는 경우, 파워 레일에 모듈을 장착하거나 제거하지 마십시오.

수리하기 전에 전원을 분리하십시오.

사용하지 않는 단자의 배선은 허용되지 않습니다.

보호 유형 [Ex ia Da]에서는 가스 그룹 IIB의 본질 안전 매개변수를 적용할 수 있습니다.

구역 2에 설치하는 경우, 모듈을 보호 유형 Ex n 또는 Ex e인 인클로저에 설치하고, 최소한 IP54의 보호 수준을 제공해야 합니다.

케이블 인입 장치와 밀폐 요소는 동일한 요구 사항을 충족해야 합니다.

구역 2의 파워 레일에 설치하는 경우, 전력 제어 장치 유형 9410(유형 시험 인증서 KEMA 07ATEX0152)의 공급을 받는 파워 레일 유형 9400만 허용됩니다.

개정일:  
2020년 6월 18일

버전 개정  
V4 R0-KR01

제작:  
PB

페이지:  
1/3

LERBAKKEN 10, 8410 RØNDE DENMARK

위험 지역

구역 0,1,2, 20, 21, 22

비위험 지역

또는 구역 2

(단자 11,12,13,14)

(단자 31,32,33,34)

(단자 91,92,93,94,95)

Um: 253 V, 최대 400 Hz

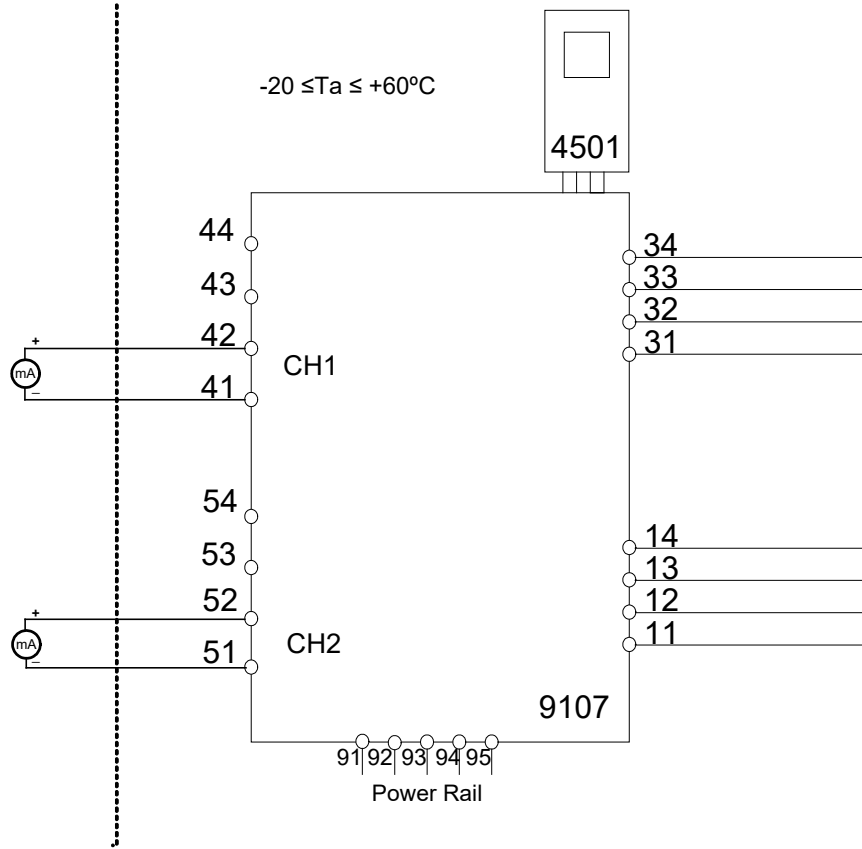

**CH1(단자 41,42)**

**CH2(단자 51,52)**

U<sub>o</sub>: 28 V  
I<sub>o</sub>: 93 mA  
P<sub>o</sub>: 0.65 W

	IIC	IIB	IIA	I
C <sub>o</sub>	0.080 μF	0.650 μF	2.15 μF	3.76 μF
L <sub>o</sub>	4 mH	16 mH	32 mH	35 mH

LERBAKKEN 10, 8410 RØNDE DENMARK

**9107Ax, 9107Bx 설치:**

위험 지역  
구역 2

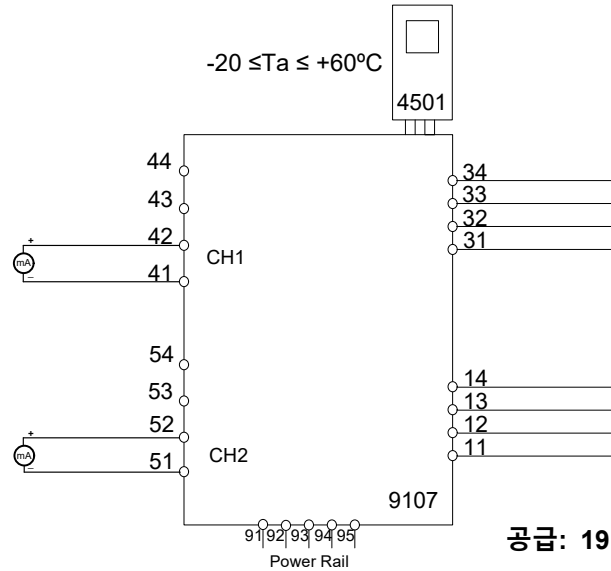

**공급: 19.2 – 31.2 VDC**  
**(단자 31,32)**  
**(단자 91,92,93,94,95)**

**입력:**  
**(단자 11,12,13,14)**

**출력**  
**CH1(단자 41,42)**  
  
**CH2(단자 51,52)**

<b>상태 릴레이. 단자(33,34)</b>		구역 2 설치
최대 전압:	125 VAC / 110 VDC	32 VAC / 32 VDC
최대 출력:	62.5 VA / 32 W	16 VA / 32 W
최대 전류:	0.5 AAC / 0.3 ADC	0.5 AAC / 1 ADC

구역 2에 설치하는 경우, 모듈을 보호 유형 Ex n 또는 Ex e인 인클로저에 설치하고, 최소한 IP54의 보호 수준을 제공해야 합니다. 케이블 인입 장치와 밀폐 요소는 동일한 요구 사항을 충족해야 합니다.

구역 2의 파워 레일에 설치하는 경우, 전력 제어 장치 유형 9410(인증서 IECEx KEM 08.0025X)의 공급을 받는 파워 레일 유형 9400만 허용됩니다.

구역 2에 설치하려면 다음 사항을 준수해야 합니다. 4501 프로그래밍 모듈은 PR 제품의 모듈과 함께 사용해야 합니다. 모듈이 손상되지 않았고, 어떤 식으로든 변경 또는 수정되지 않는 것이 중요합니다. 먼지와 습기가 없는 상태에서 4501 모듈을 설치해야 합니다.

개정일:	버전 개정	제작:	페이지:
2020년 6월 18일	V4 R0-KR01	PB	3/3

## Document history

The following list provides notes concerning revisions of this document.

<b>Rev. ID</b>	<b>Date</b>	<b>Notes</b>
104	1901	Specifications for max. required power added. FM and INMETRO certificate numbers updated. Installation drawings updated.
105	1945	9107A-version included in manual. Variant with UL 913 approval added. CCOE approval discontinued.
106	2027	New FM certificate and installation drawing.
107	2103	ATEX and IECEx installation drawings updated. CCC approval added.
108	2316	UKEX approval added. Variant with Korean KCs approval added.



# We are near you, *all over the world*

**Our trusted red boxes are supported wherever you are**

All our devices are backed by expert service and a 5-year warranty. With each product you purchase, you receive personal technical support and guidance, day-to-day delivery, repair without charge within the warranty period and easily accessible documentation.

We are headquartered in Denmark, and have offices and authorized partners the world over. We are a local

business with a global reach. This means that we are always nearby and know your local markets well. We are committed to your satisfaction and provide PERFORMANCE MADE SMARTER all around the world.

For more information on our warranty program, or to meet with a sales representative in your region, visit [prelectronics.com](http://prelectronics.com).

# Benefit today from *PERFORMANCE MADE SMARTER*

PR electronics is the leading technology company specialized in making industrial process control safer, more reliable and more efficient. Since 1974, we have been dedicated to perfecting our core competence of innovating high precision technology with low power consumption. This dedication continues to set new standards for products communicating, monitoring and connecting our customers' process measurement points to their process control systems.

Our innovative, patented technologies are derived from our extensive R&D facilities and from having a great understanding of our customers' needs and processes. We are guided by principles of simplicity, focus, courage and excellence, enabling some of the world's greatest companies to achieve PERFORMANCE MADE SMARTER.